

PRODUCT DATA SHEET – LTX-10

Section 1. PRODUCT DESCRIPTION

HAMMER DRIVEN FASTENER WITH PLASTIC PIN AND SHORT

EXPANSION ZONE – LTX-10

Hammer driven fastener with plastic pin and short expansion zone LTX-10 is made from polyethylene, and the pin from glass fibre-reinforced polyamide which improves its strength. Fastener LTX-10 should be used to transfer loads of wind suction forces and applied as an additional mechanical fixing for the whole system, recommended for:

- EPS polystyrene
- XPS polystyrene

Types of substrates on which fastener LTX-10 can be installed according to ETAG 014:

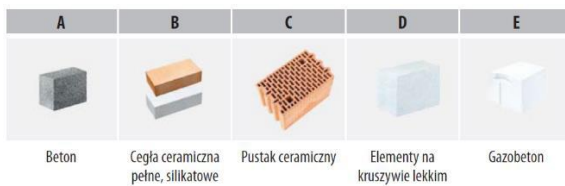

Fasteners hold European Technical Assessment: **ETA-16/0509**



NOWA ULEPSZONA KONSTRUKCJA
- zakotwienie: 30 i 50 mm



Trzpień wzmocniony włóknem szklanym



Specjalny kołnierz łącznika



Innowacyjna konstrukcja koszulki



Section 2. METHOD OF INSTALLATION

1. Before installation identify the substrate and select suitable fasteners
2. Select adequate length of the fastener so that expansion zone is in the construction material of the wall
3. Minimum length of the fastener is: $L_d = t_{fix} + t_{tot} + h_{eff}$, where: t_{fix} - thickness of insulation material to be fixed, t_{tot} - thickness of sub-crusts (adhesive + existing plaster), h_{eff} - depth of fastener anchorage in the substrate (given in the sheet and in Technical Approval)
4. Before installation prepare the substrate as recommended by ETICS manufacturer
5. Fix thermal insulation panels correctly using an adhesive
6. Diameter of drilled holes should match diameter of the fasteners used
7. Drilled holes in substrates of solid materials should be deeper by min. 10 mm compared to the fastener anchorage depth
8. Clean the holes drilled in solid materials of drillings with a back and forth motion of the drill at a reduced speed, repeating it four times
9. Drill the holes in substrates of hollowed bricks and aerated concrete without impact as this will cause breakage of inner walls of the substrate and reduce pull-out resistance of fasteners
10. Number of fasteners per 1m² should be defined in thermal insulation design. Recommended number of fasteners: FOR POLYSTYRENE:
 - up to the height of 15m from the ground, as minimum use 6pcs/m² in the middle area of a wall and 8pcs/m² in a corner area
 - above 15m from the ground, as minimum use 8pcs/m² in the middle area of a wall and 10pcs/m² in a corner area**Recommendation shall not replace thermal insulation design!!**
11. Fix the fasteners so that the installation spot matches the area where adhesive is placed on a thermal insulation panel
12. Embed the fastener body so that the fastener washer is faced with thermal insulation material
13. Then drive the fastener pin to firmly attach the fastener
14. Do not drive fasteners in when the pin is already driven as otherwise they may break
15. Fasteners can be installed in cut holes using plastic cutter for cutting holes in polystyrene **WK-FT** – so-called immersed mount

• Montaż widoczny

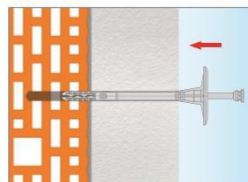
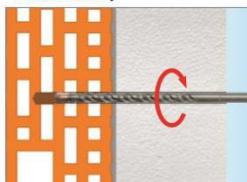

• Montaż zagłębiony z krążkiem styropianowym

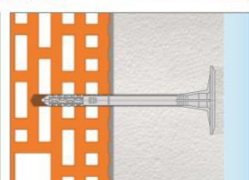
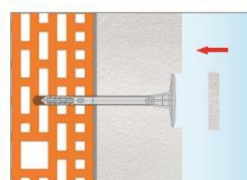
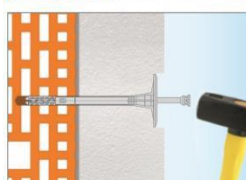
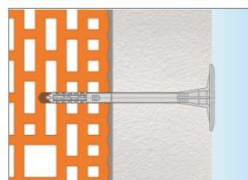
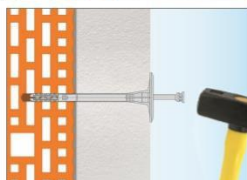
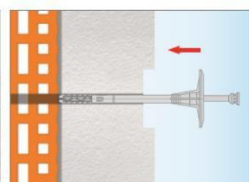
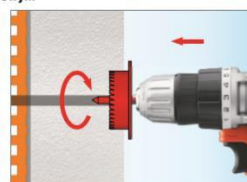

PRODUCT DATA SHEET – LTX-10

Section 3. TECHNICAL DATA

TECHNICAL PARAMETERS			
Parameter	Unit	Value	
Plug diameter	d_k [mm]	10	
Plate diameter	D_k [mm]	60	
Anchorage depth	h_{eff} [mm]	30/50*	
Drilled hole depth	h_0 [mm]	40/60*	
Thermal conductivity	χ [W/K]	surface mount	immersed mount
		0.001	0.000
Washer stiffness	S [kN/mm]	0.50	
Use categories	[-]	A B C D E	
Fastener material	[-]	PE	
Pin material	[-]	PA + GF	
European Technical Assessment	[-]	ETA-16/0509	

*for substrate use category E (aerated concrete)

STRENGTH PARAMETERS			
Substrate category	Substrate type	Density [kg/dm ³]	Characteristic pull-out resistance [kN]
A	Concrete C12/15	≥ 2.25	0.50
A	Concrete C20/25 – C50/60	≥ 2.30	0.75
B	Solid clay brick	≥ 2.00	0.75
B	Calcium silica solid brick	≥ 2.00	0.60
C	Calcium silicate hollow blocks	≥ 1.60	0.60
C	Perforated brick	≥ 1.20	0.60
C	Porotherm 25	≥ 0.80	0.40
D	Lightweight concrete blocks	≥ 0.88	0.60
E	Autoclaved aerated concrete AAC2	≥ 0.35	0.50
E	Autoclaved aerated concrete AAC7	≥ 0.65	0.60

Partial safety factor $\gamma_M=2$ in absence of regulations

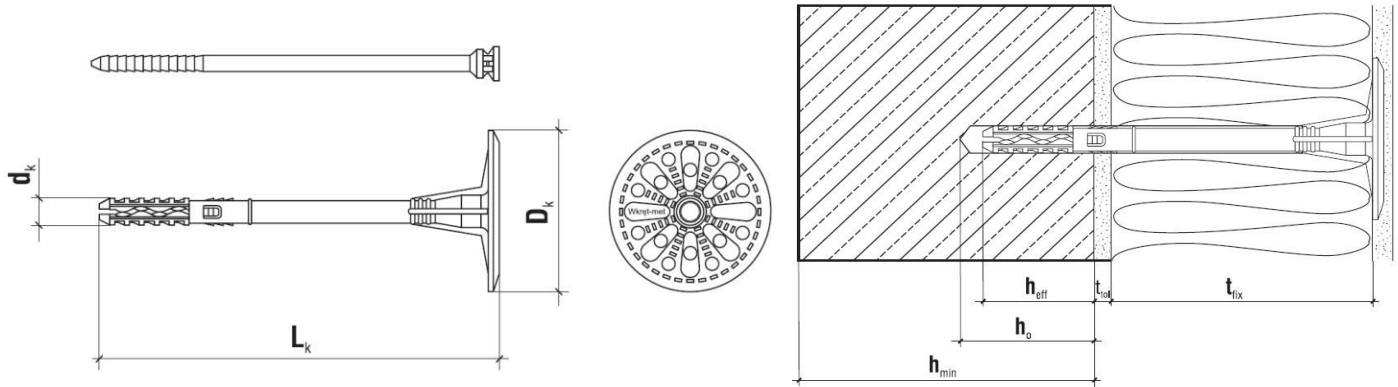

SELECTION TABLE						
Product code	Fastener diameter and length ($d_k \times L_k$)	Insulation material thickness t_{fix} [mm]				Number of pieces in a box
		New buildings (t_{tot} adhesive layer of 10mm)		Old buildings (t_{tot} adhesive layer of 10mm + 20mm of old plaster)		
		Without cutter	With cutter	Without cutter	With cutter	
LTX-10070	10x70	30/10*	50/30*	10/-*	30/10*	200
LTX-10090	10x90	50/30*	70/50*	30/10*	50/30*	200
LTX-10110	10x110	70/50*	90/70*	50/30*	70/50*	200
LTX-10120	10x120	80/60*	100/80*	60/40*	80/60*	200
LTX-10140	10x140	100/80*	120/100*	80/60*	100/80*	200
LTX-10160	10x160	120/100*	140/120*	100/80*	120/100*	200
LTX-10180	10x180	140/120*	160/140*	120/100*	140/120*	200
LTX-10200	10x200	160/140*	180/160*	140/120*	160/140*	200
LTX-10220	10x220	180/160*	200/180*	160/140*	180/160*	100
LTX-10260	10x260	220/200*	240/220*	200/180*	220/200*	100

*for substrate use category E (aerated concrete)

Section 4. REMARKS

1. All previous versions of this Product Data Sheet shall cease to be valid
2. Data given in this Product Data Sheet is in accordance with current knowledge and published in good faith. KLIMAS Sp. z o.o. is not responsible for correctness and quality of the fixing if recommendations regarding method of use and installation are not followed.